

## Thermozone ADA

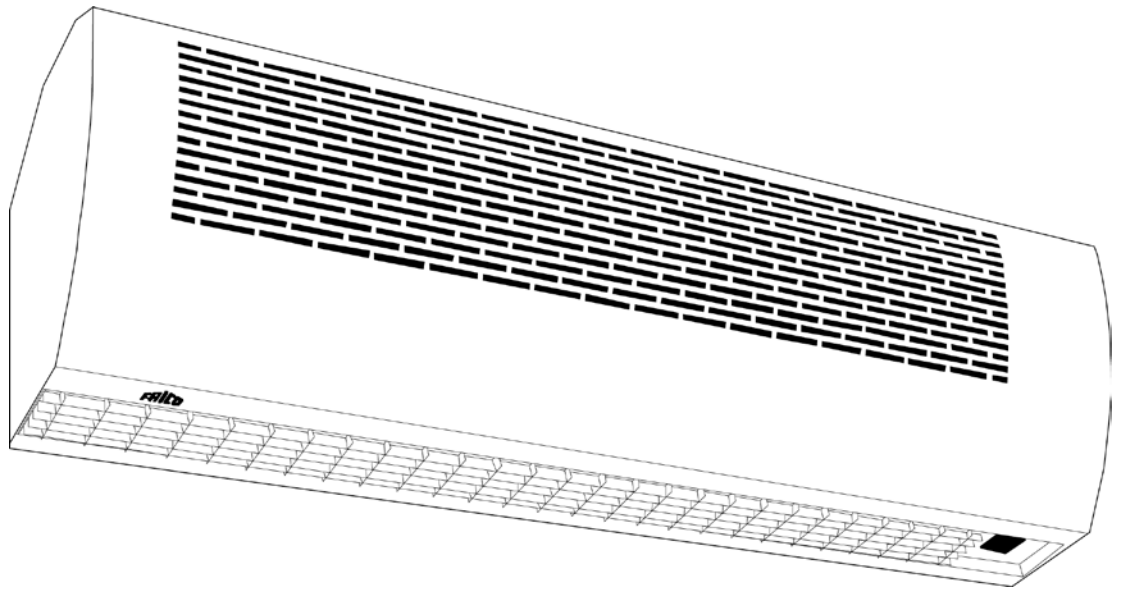

SE<sup>2</sup>

GB<sup>2</sup>

NO<sup>2</sup>

FR<sup>2</sup>

RU<sup>2</sup>

DE<sup>2</sup>

PL<sup>2</sup>

FI<sup>2</sup>

ES<sup>2</sup>

NL<sup>2</sup>

# Thermozone ADA

1

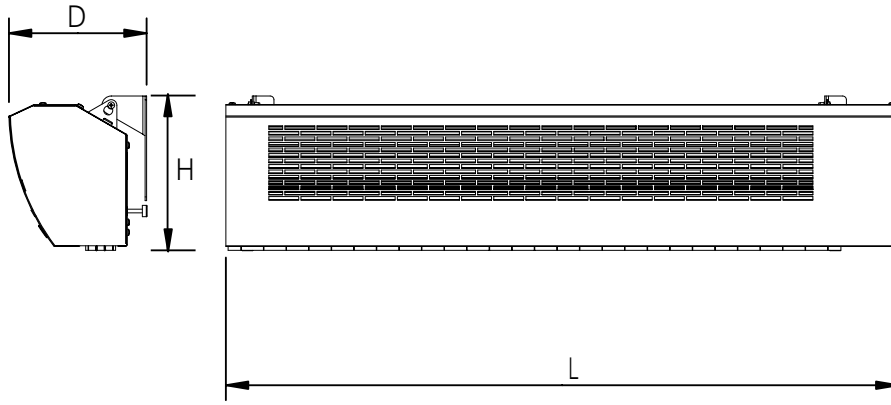

	<b>L</b>	<b>H</b>	<b>D</b>	
<b>090L</b>	900	190	175	mm
<b>090H</b>	900	235	215	mm
<b>120L</b>	1200	190	175	mm
<b>120H</b>	1200	235	215	mm

2

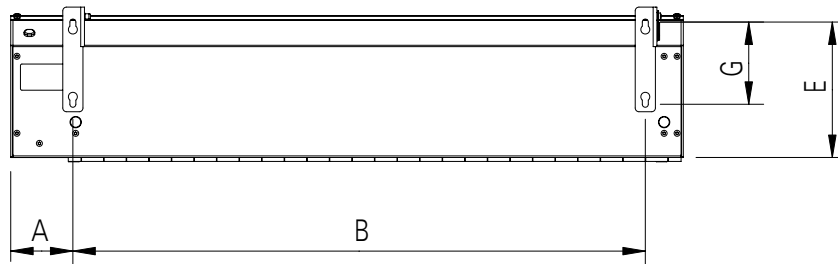

	<b>A</b>	<b>B</b>	<b>E</b>	<b>G</b>	
<b>090L</b>	87	800	170	90	mm
<b>090H</b>	95	747	216	110	mm
<b>120L</b>	87	1100	170	90	mm
<b>120H</b>	95	1047	216	135	mm

3

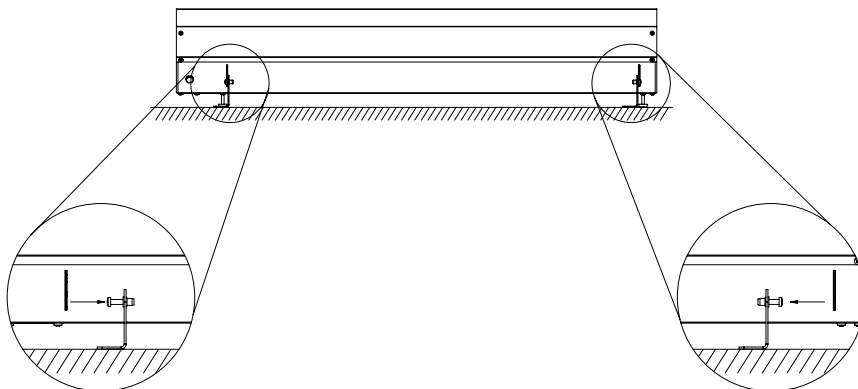

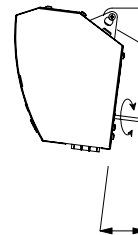

4

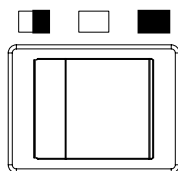

## Thermozone ADA



			
<b>090L</b>	625	820	m³/h
<b>090H</b>	800	1150	m³/h
<b>120L</b>	900	1350	m³/h
<b>120H</b>	1100	1400	m³/h



<b>090L</b>	8.7 kg	54 dB(A)
<b>090H</b>	9.5 kg	54 dB(A)
<b>120L</b>	10.8 kg	55 dB(A)
<b>120H</b>	11.7 kg	51 dB(A)

- SE: En skadad nätkabel får endast bytas av en behörig installatör
- GB: A damaged mains cable must only be changed by a competent electrician.
- NO: En skadet nettledning skal kun byttes av godkjent installatør.
- FR: Un câble d'alimentation défectueux ne doit être remplacé que par un électricien qualifié.
- RU: В случае повреждения питающего кабеля он должен быть заменен квалифицированным электриком.
- DE: Ein beschädigtes Netzkabel darf nur durch einen ausgebildeten Elektriker ausgetauscht werden.
- PL: Zniszczone przewody elektryczne mogą być wymienione tylko przez elektryka posiadającego odpowiednie uprawnienia elektryczne.
- FI: Vahingoittuneen verkkojohdon saa vaihtaa vain valtuutettu asentaja.
- ES: Un cable principal dañado sólo debe ser sustituido por un electricista cualificado.
- NL: Beschadigde bedrading mag uitsluitend door een bevoegde elektromonteur worden vervangen / gerepareerd.

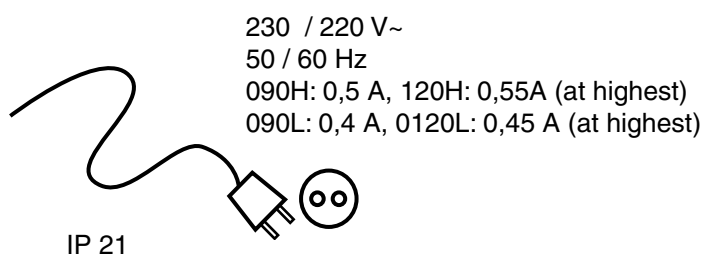

**Main office**

Frico AB  
Box 102  
SE-433 22 Partille  
Sweden

Tel: +46 31 336 86 00  
Fax: +46 31 26 28 25  
mailbox@frico.se  
www.frico.se

**For latest updated information and information  
about your local contact: [www.frico.se](http://www.frico.se)**



[www.frico-ltd.ru](http://www.frico-ltd.ru) [info@frico-ltd.ru](mailto:info@frico-ltd.ru) +7 (495) 215-02-37  
Москва. Каширский проезд д. 17 стр. 5